

SLE 66R35

Intelligent 1 kByte Memory Chip
with Mifare compatibility and 4-byte UID

SLE 66R35I

Intelligent 1 kByte Memory Chip
with Mifare compatibility and
4-byte Fixed Non Unique IDentification Number

SLE 66R35R

Intelligent 1 kByte Memory Chip
with Mifare compatibility and
4-byte Fixed reused Identity Number

Short Product Information

June 2014

SLE 66R35(I, R) Short Product Information		Ref.: SLE66R35(I-R)_ShortProductInfo_2011-03.doc
Revision History: Current Version 2014-06-05		
Previous Releases: 2011-03-10		
Page	Subjects (changes since last revision)	
4	Ordering Information: SLE 66R35 is discontinued	
8 and 9	Clarification on reused IDs (r-ID) applicable for SLE 66R35R	

Remark:

Mifare is only used as an indicator of product compatibility to the respective technology.

Important: For further information please contact:
 Infineon Technologies AG in Munich, Germany,
 Chip Card & Security,
 E-Mail: security.chipcard.ics@infineon.com

Published by Infineon Technologies AG, CCS Applications Group
D-81726 München
© Infineon Technologies AG 2014
All Rights Reserved.

To our valued customers

We constantly strive to improve the quality of all our products and documentation. We have spent an exceptional amount of time to ensure that this document is correct. However, we realize that we may have missed a few things. If you find any information that is missing or appears in error, please use the contact section above to inform us. We appreciate your assistance in making this a better document.

Attention please!

The information herein is given to describe certain components and shall not be considered as warranted characteristics.

Terms of delivery and rights to technical change reserved.

We hereby disclaim any and all warranties, including but not limited to warranties of non-infringement, regarding circuits, descriptions and charts stated herein.

Infineon Technologies is an approved CECC manufacturer.

Information

For further information on technology, delivery terms and conditions and prices please contact your nearest Infineon Technologies Office in Germany or our Infineon Technologies Representatives world-wide (see address list).

Warnings

Due to technical requirements components may contain dangerous substances. For information on the types in question please contact your nearest Infineon Technologies Office.

Infineon Technologies components may only be used in life-support devices or systems with the express written approval of Infineon Technologies, if a failure of such components can reasonably be expected to cause the failure of that life-support device or system, or to affect the safety or effectiveness of that device or system. Life support devices or systems are intended to be implanted in the human body, or to support and/or maintain and sustain and/or protect human life. If they fail, it is reasonable to assume that the health of the user or other persons may be endangered.

Intelligent 1 kByte Memory Chip with Mifare compatibility

- **SLE 66R35** 4-byte fixed unique number (UID) ^{1) 2)}
- **SLE 66R35I** 4-byte fixed number, non unique (FNUID)
- **SLE 66R35R** 4-byte fixed reused identity number (r-ID)

Features

Contactless Interface

- Physical Interface and Anticollision compliant to ISO/IEC 14443-2 and -3 Type A
 - Operating frequency 13.56 MHz; data rate 106 kbit/s
 - Contactless transmission of data and supply energy
 - Anticollision logic: several cards may be operated in the field simultaneously
- Read and write distance up to 10 cm and more (influenced by external circuitry i.e. reader and inlay design)
- Short transaction times: Typical ticketing transaction < 100 ms; transaction possible when card is moving

1 kByte EEPROM

- Block organization of memory, 16 sectors with fixed 4 blocks of 16 bytes each
- EEPROM updating time per block less than 4 ms
- Endurance > 100,000 erase / write cycles / bit ³⁾
- Data retention > 10 years ²⁾
- User definable access condition for each memory block

Security Features

- SLE66R35: 4-byte Unique Identifier (UID) ^{1) 2)}
- SLE66R35I: 4-byte fixed non unique number (FNUID)
- SLE66R35R: 4-byte fixed reused identity number (r-ID), 4-byte UID previously issued
- Mutual three-pass authentication between card and reader for basic security
 - 48-bit key length
 - 2 keys per sector enabling key management
 - Transport key at chip delivery
- Selective memory access secured by authentication and access conditions
- Suited to multifunctional applications: individual key sets for each EEPROM sector
- Data encryption for RF channel
- Dedicated Value Counter
- Data integrity supported by CRC, Parity Check, etc.

Electrical characteristics

- On-Chip capacitance 18.3 pF ± 10%
- ESD protection typical 2 kV
- Ambient temperature –25 ... +70°C for chip

¹⁾ Note: The available numbers are already exhausted

²⁾ Discontinued, consider to use successor products SLE 66R35I, SLE 66R35R or SLE 66R35E7

³⁾ Values are temperature dependent

1 Ordering and Packaging information

Table 1 Ordering Information

Type	Package ¹⁾	Remark	Ordering Code
SLE 66R35 C ²⁾	Die (on Wafer)	sawn / unsawn	discontinued
SLE 66R35 NB ²⁾	Die (on Wafer)	NiAu-Bump, sawn	discontinued
SLE 66R35 MCC2 ²⁾	P-MCC2-2-1		discontinued
SLE 66R35 MCC8 ²⁾	P-MCC8-2-3		discontinued
SLE 66R35I C	Die (on Wafer)	sawn / unsawn	on request
SLE 66R35I NB	Die (on Wafer)	NiAu-Bump, sawn	on request
SLE 66R35I MCC2	P-MCC2-2-1		on request
SLE 66R35I MCC8	P-MCC8-2-6		on request
SLE 66R35R C	Die (on Wafer)	sawn / unsawn	on request
SLE 66R35R NB	Die (on Wafer)	NiAu-Bump, sawn	on request
SLE 66R35R MCC2	P-MCC2-2-1		on request
SLE 66R35R MCC8	P-MCC8-2-6		on request

For more ordering information (wafer thickness and height of NiAu-Bump) please contact your local Infineon sales office.



Figure 1 Pin Configuration Module Contactless Card MCC2 (top view)

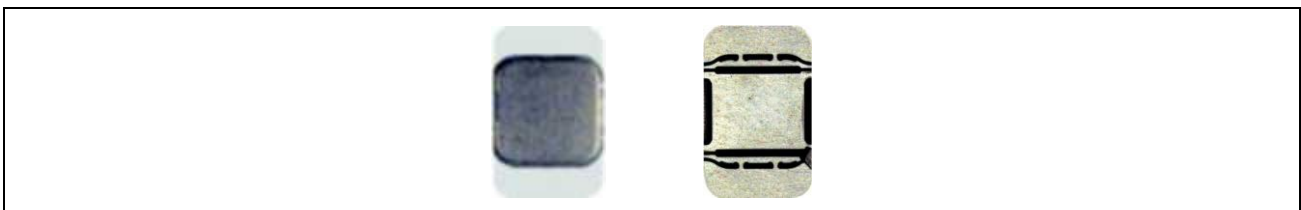

Figure 2 Pin Configuration Module Contactless Card MCC8-2-3 (top / bottom view)

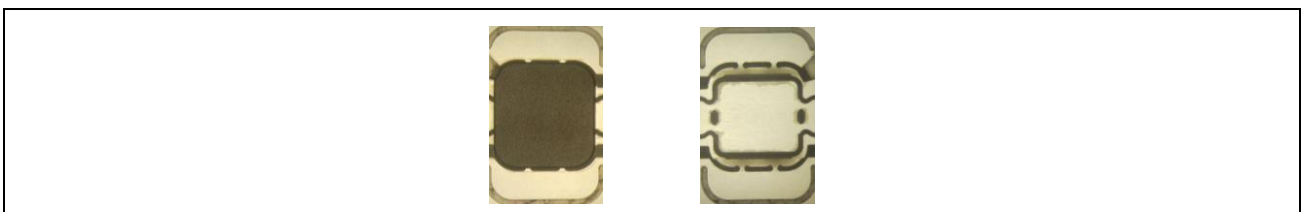

Figure 3 Pin Configuration Module Contactless Card - MCC8-2-6 in (top / bottom view)

¹⁾ Available as a Module Contactless Card (MCC) for embedding in plastic cards, as NiAu-bump version (NB) or as a die on sawn / unsawn wafer for customer packaging

²⁾ Discontinued, consider to use successor products SLE 66R35I, SLE 66R35R or SLE 66R35E7

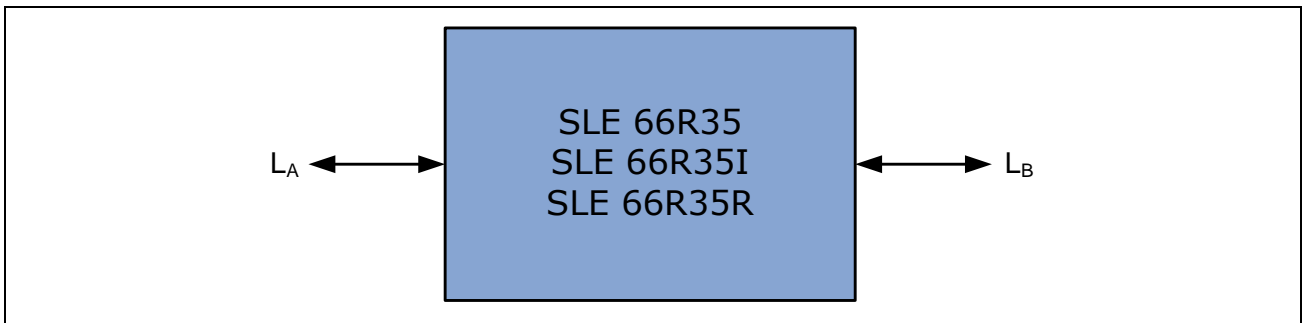

Figure 4 Pad Configuration Die

Table 2 Pin Definitions and Functions

Symbol	Function
L _A	Antenna Connection
L _B	Antenna Connection

2 Overview of a Mifare compatible System

The SLE 66R35 / SLE 66R35I / SLE 66R35R is designed to operate in a Mifare compatible system. The system consists of a smart card and a card reader together with an antenna.

The operating distance between card and reader antenna is up to 10 cm and more (influenced by external circuitry i.e. reader-antenna configuration). The card's antenna consists of a simple coil with a few turns embedded in plastic.

The RF communication interface transmits at 106 kbit/s resulting in short transaction times, the effect being that a card user can move freely through a reader gate with minimum disruption. A typical ticketing transaction can be handled in less than 100 ms. Robust contactless transmission means that the card with SLE 66R35 / SLE 66R35I / SLE 66R35R may also remain in the wallet of the user even if there are coins in it.

An intelligent anticollision function based on the chip single size identifier (uid0 – uid3) enables more than one card in the field to operate simultaneously. The anticollision algorithm selects each card individually and ensures that the execution of a transaction with a selected card is performed correctly without data corruption resulting from other cards in the field.

Access to SLE 66R35 / SLE 66R35I / SLE 66R35R is only allowed after a three pass authentication. Each data transmission is enciphered. Protection from misuse is done by configurable access conditions that are protected by secret keys used for memory operations such as read or write.

Multi-Application Functionality

The SLE 66R35 / SLE 66R35I / SLE 66R35R is suited for the use in multi-application schemes, for example combining a transportation fare collection scheme and a ticketing system such as stadium ticketing. Both applications can be performed with the same card, as hierarchical key management is supported. This means that two different keys for each memory sector can be assigned to enable authentication to that sector.

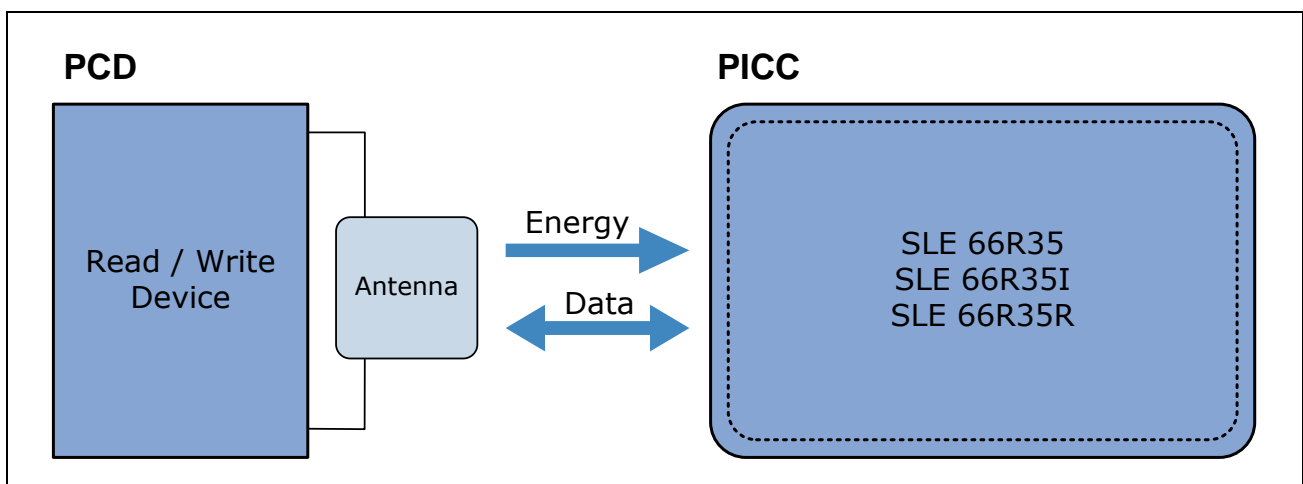

Figure 5 System Overview

3 Circuit Description

SLE 66R35 / SLE 66R35I / SLE 66R35R consist of an EEPROM memory of 1 kByte organized in 16 sector with 4 blocks each containing 16 bytes, an analog interface for contactless energy and data transmission and a control unit. The power supply and data are transferred to SLE 66R35 / SLE 66R35I / SLE 66R35R via an antenna, which consists of a coil with few turns directly connected to the module. No further external components are necessary. The circuit is designed to communicate with a card-reader at an operating distance of up to 10 cm (or more) depending on the reader-antenna configuration.

The chip is designed to meet the cost-optimized requirements of a basic security level. The targeted applications are transport, corporate access, events and loyalty cards with basic security requirements.

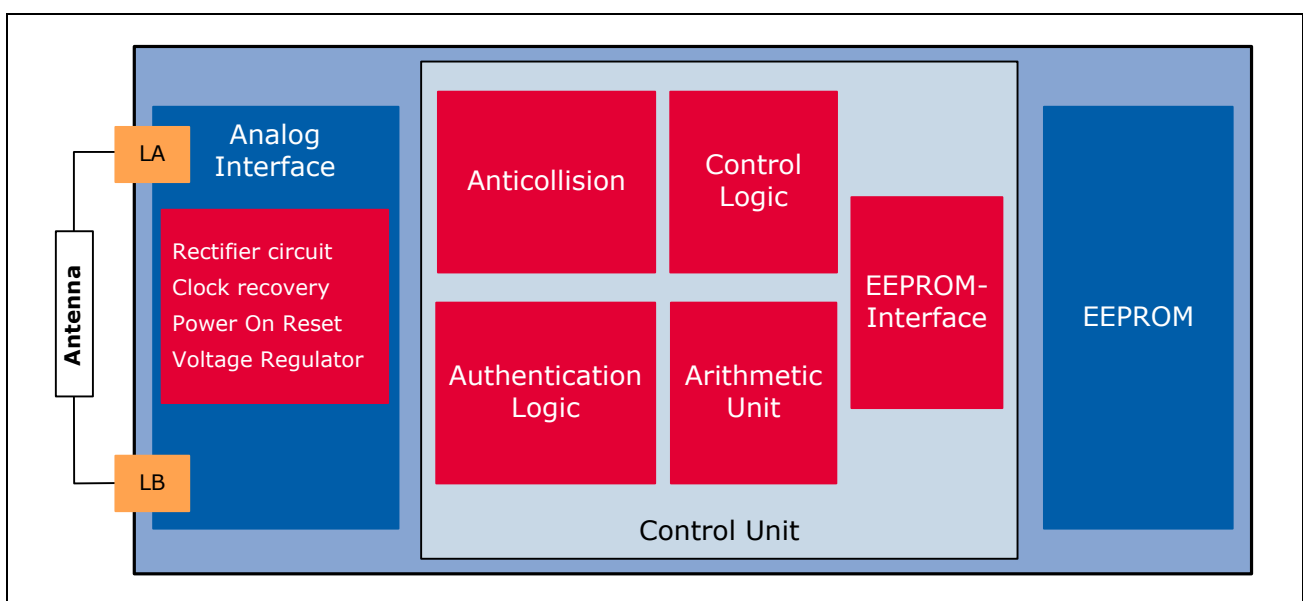

Figure 6 Block Diagram

- Analog Contactless Interface**
 The Analog Contactless Interface comprises the voltage rectifier, voltage regulator and system clock to supply the IC with appropriate power. Additionally the data stream is modulated and demodulated.
- Anticollision**
 Internal logic of SLE 66R35 / SLE 66R35I / SLE 66R35R ensures the recognition of several cards in the field, which may be selected and operated in sequence. The Anticollision loop is based on Single Size UID according to ISO/IEC 14443-3
- Authentication Logic**
 Correct execution of any memory operation can only occur after the authentication procedure with a specific key
- Control Logic**
 Access to a block is defined by the associated access conditions for that block. These are programmed individually for each block in a sector.
- Arithmetic Unit**
 Arithmetic Capability: increment and decrement of values stored in a special redundant format.
- EEPROM:** 1 kByte organized in 16 sectors with 4 blocks by 16 bytes each. The last block of each sector is called "Sector Trailer" and is used to store a pair of secret keys and programmable access conditions for each block.

4 Migration Information

4.1 Structures of UIDs according to ISO/IEC 14443-3 Type A

The UID consists of 4, 7 or 10 UID bytes. Consequently, the PCD shall handle up to 3 cascade levels to get all UID bytes from the PICC. Within each cascade level a part of UID shall be transmitted to the PCD.

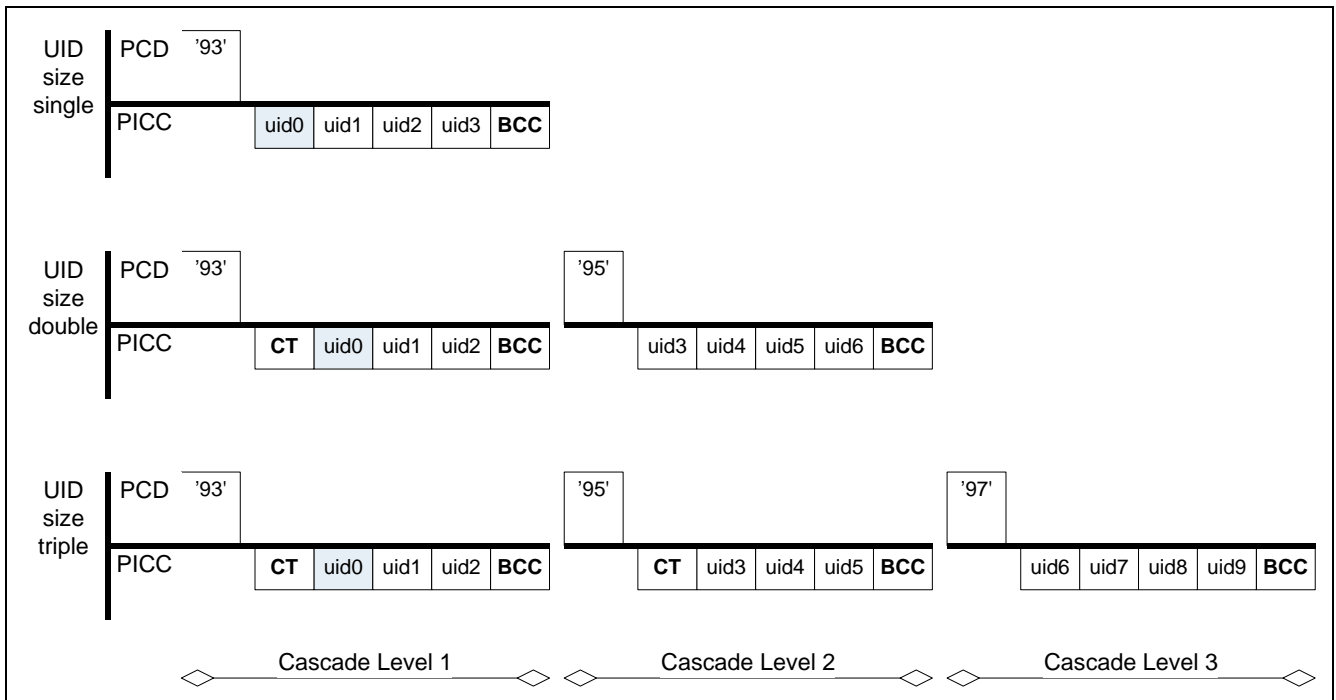

Figure 7 Structures of UID contents and cascade levels according to ISO/IEC 14443-3 Type A

Table 3 Overview on Chip Types using Mifare Technology

Type	UID size	UID type	uid0	Description
SLE 66R35 ^{1) 2)}	4-byte	UID	xM _H y8 _H	Fixed unique number programmed by manufacturer (M = 1, 5, 7, 9) (y = 1, 2, 3, 4, 5)
SLE 66R35I	4-byte	FNUID	xF _H	Fixed number, non-unique programmed by manufacturer
SLE 66R35R	4-byte	r-ID	xM _H	Fixed reused identity number programmed by manufacturer (M = 1, 5, 7, 9). Other values might be applicable without further notice.
SLE 66R35E7	7-byte	UID	05 _H	Fixed unique number programmed by manufacturer. uid0 contains Manufacturer ID according to ISO/IEC 7816-6

Note: 'x' is part of the serial number

¹⁾ Note: The available numbers are already exhausted

²⁾ Discontinued, consider to use successor products SLE 66R35I, SLE 66R35R or SLE 66R35E7

4.2 SLE 66R35^{1) 2)}

- Fixed Unique number (UID)**

uid0 = 'xM' / 'y8' defines a unique fixed number (used for Single-Size UIDs) according to ISO/IEC 14443-3:2010. During chip manufacturing M / y is set to the values 1, 5, 7, 9 respectively 1, 2, 3, 4, 5 as a part of the serial number programmed to uid0 to uid3.

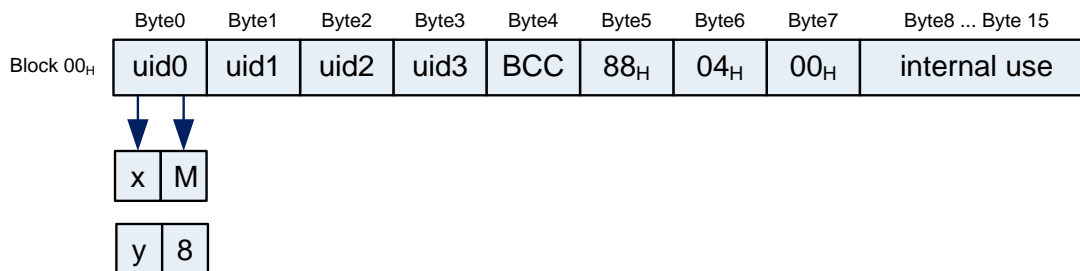

4.3 SLE 66R35I

- Fixed number, non unique (FNUID)**

uid0 = 'xF' defines a non-unique fixed number (used for Single-Size UIDs) according to ISO/IEC 14443-3:2010. As a result the 4-byte numbering is not limited; consequently more cards with the same ID number might exist in the future. During chip manufacturing the serial number is programmed to uid0 to uid3.

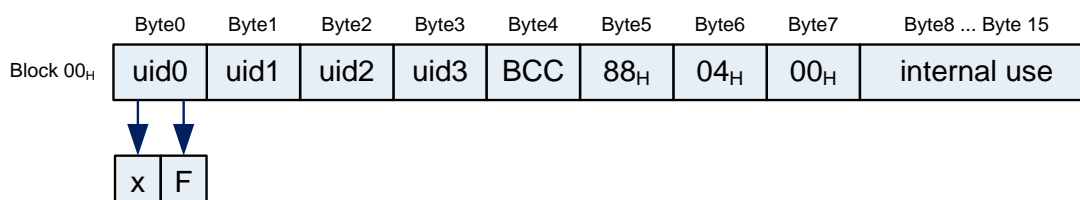

4.4 SLE 66R35R

- Fixed reused identity number (r-ID)**

uid0 = 'xM' defines a fixed reused identity number (used for Single-Size UIDs). During chip manufacturing M is set to the values 1, 5, 7, 9 (other values might be applicable without further notice) as a part of the serial number programmed to uid0 to uid3.

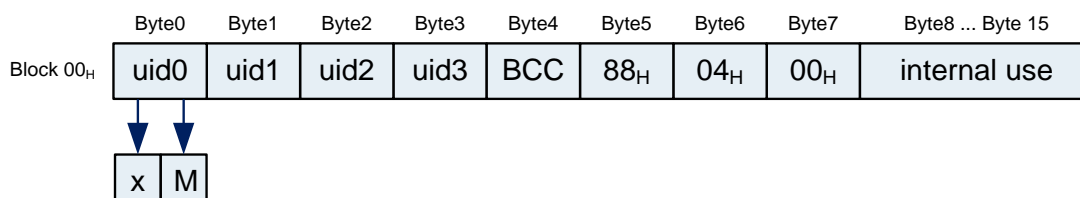

¹⁾ Note: The available numbers are already exhausted

²⁾ Discontinued, consider to use successor products SLE 66R35I, SLE 66R35R or SLE 66R35E7